































BRUSHCUTTER AND TRIMMER BLADES

TURFMASTER no.	Description	Replaces	Model OEM NO.	HOLE SIZE	Image may not depict the actual size, shape, etc.
AAB17001	Blade, with anti-rust oiled. No heat treatment. 7.75"L x 2"W x 1"Hole x 0.120T.	Echo, Maruyama, Shindaiwa.	720237001, 69601552631, 72950-92110	1" 25.4mm	
AAB17002	Blade, Black color. Heat treated. 7.75"L x 2"W x 1"Hole x 0.121T.	Echo, Maruyama, Shindaiwa.	720237001, 69601552631, 72950-92110	1" 25.4mm	
AAB17013	Blade, 70 x 305 x 1.4mm, Hole 1", Material: SKS51	Universal		1" 25.4mm	
AAS005	2 TOOTH 70 x 350 x 1.4mm x 1" Material S45C 1.4 MM			 25.4mm	
AAS015/A	2 TOOTH 90 x 350 x 1.5mm x 1" Material S45C 1.5MM	NEW		 25.4mm	
AAS006	2 TOOTH 90 x 350 x 1.6mm x 1" Material S45C 1.6MM			 25.4mm	
AAS015ST	2 TOOTH 90 x 350 x 1.6mm x 1" Material S45C 2.5MM	NEW		 20.0mm	









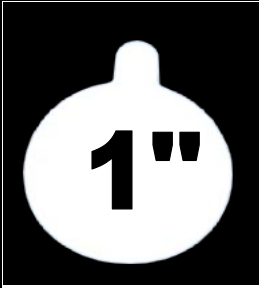

BRUSHCUTTER AND TRIMMER BLADES

TURFMASTER no.	Description	Replaces	Model OEM NO.	HOLE SIZE	Image may not depict the actual size, shape, etc.
AAS015	<p>2 TOOTH</p> <p>90 x 350 x 1.6mm x 1" Material S45C 2.5MM</p>	NEW		 <p>1"</p> <p>25.4mm</p>	
AAB17010	<p>2 TOOTH</p> <p>75 x 313 x 3.1mm x 1" Material S45C 3.1MM Mulchblade</p>			 <p>1"</p> <p>25.4mm</p>	
AAB199916	<p>3 TOOTH</p> <p>10" x 3mm x 25.4 Material S45C 255MM</p>			<p>1"</p> <p>25.4mm</p>	
AAS001ST	<p>3 TOOTH</p> <p>10" x 3mm x 25.4 Material S45C 255MM</p>			 <p>0.8"</p> <p>20.0mm</p>	
AAS001	<p>3 TOOTH</p> <p>10" x 3mm x 25.4 Material S45C 255MM</p>			 <p>1"</p> <p>25.4mm</p>	







BRUSHCUTTER AND TRIMMER BLADES

TURFMASTER no.	Description	Replaces	Model OEM NO.	HOLE SIZE	Image may not depict the actual size, shape, etc.
AAB17018	3 TOOTH 10" x 3mm x 25.4 Material SK5 255MM		4110-713-4100	 1" 25.4mm	
AAS002ST	3 TOOTH 12" x 3mm x 25.4 Material S45C 305MM			 0.8" 20.0mm	
AAS002 AAB17020	OR 3 TOOTH 12" x 3mm x 25.4 Material S45C 305MM			 1" 25.4mm	
AAS016	3 TOOTH 12" x 4mm x 20.0 Material S45C 305MM 4 MM			 0.8" 20.0mm	
AAS003ST	3 TOOTH 14" x 3mm x 25.4 Material S45C 355MM			 0.8" 20.0mm	

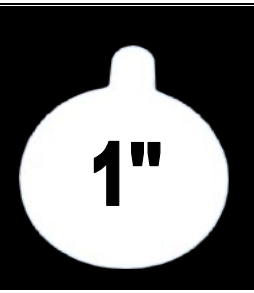
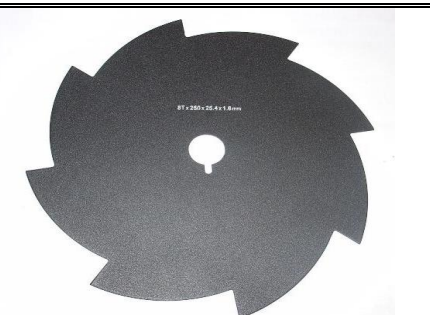
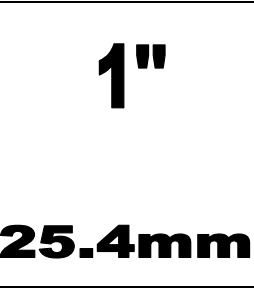
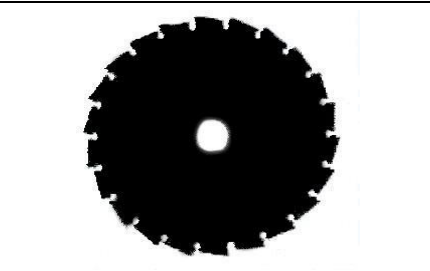
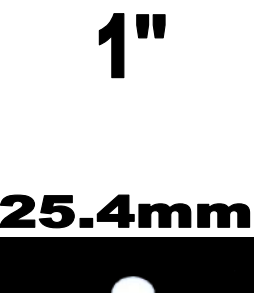
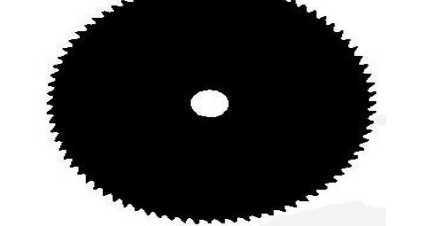

BRUSHCUTTER AND TRIMMER BLADES

TURFMASTER no.	Description	Replaces	Model OEM NO.	HOLE SIZE	Image may not depict the actual size, shape, etc.
AAS003	<p>3 TOOTH</p> <p>14" x 3mm x 25.4 Material S45C 355MM</p>			 <p>25.4mm</p>	
AAS008	<p>3 TOOTH</p> <p>12" x 3mm x 25.4 Material S45C " Mulchblade"</p>			 <p>25.4mm</p>	
AAB17021	<p>4 TOOTH</p> <p>10" x 1.4mm x 25.4 Material SK5 (255MM)</p>			<p>1"</p> <p>25.4mm</p>	
AAS004	<p>4 TOOTH</p> <p>10" x 1.4mm x 25.4 Material S45C (255MM)</p>			 <p>25.4mm</p>	
AAB17024	<p>8 TOOTH</p> <p>10" x 1.6mm x 1" Material SK5 (255MM)</p>			<p>1"</p> <p>25.4mm</p>	
AAS007ST	<p>8 TOOTH</p> <p>10" x 1.6mm x 1" Material S45C (255MM)</p>			 <p>20.0mm</p>	

BRUSHCUTTER AND TRIMMER BLADES

TURFMASTER no.	Description	Replaces	Model OEM NO.	HOLE SIZE	Image may not depict the actual size, shape, etc.
AAS007	<p>8 TOOTH</p> <p>10" x 1.6mm x 1" Material S45C (255MM)</p>			 25.4mm	
AAST395-329	<p>22 TOOTH</p> <p>9" x 1.8mm x 1" Material SK5 (255MM)</p>			 25.4mm	
AAB17025	<p>80 TOOTH</p> <p>10" x 1.4mm x 1" Material SK5 (255MM)</p>			 25.4mm	
AAS010	<p>40 TOOTH</p> <p>10" x 2.0 1.3 x 1" Material S45C (255MM)</p>			 25.4mm	
AAS012	<p>40 TOOTH</p> <p>10" X 2.2 1.6 X 1" Material S45C (255MM)</p>			 25.4mm	
AAS013	<p>40 TOOTH</p> <p>12" x 2.0 1.3 x 1" Material S45C (305MM)</p>			 25.4mm	

BRUSHCUTTER AND TRIMMER BLADES

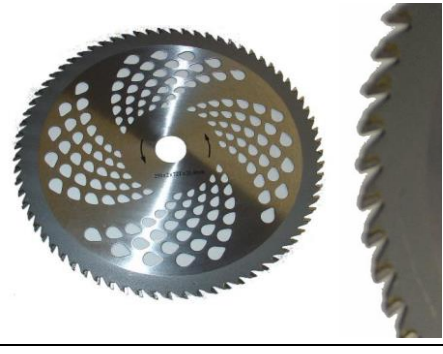
TURFMASTER no.	Description	Replaces	Model OEM NO.	HOLE SIZE	Image may not depict the actual size, shape, etc.
AAS014	<p>60 TOOTH</p> <p>12" x 2.0 1.3 x 1" Material S45C (305MM)</p>			 <p>1" 25.4mm</p>	
AAS011	<p>72 TOOTH</p> <p>10" x 2.0 1.3 x 1" Material S45C (255MM)</p>			 <p>1" 25.4mm</p>	
AAS001SP1.6	Blade Spacer from 25.4mm to 20mm Thick 1.6mm				
AAS001SP3.0	Blade Spacer from 25.4mm to 20mm Thick 3.0mm				